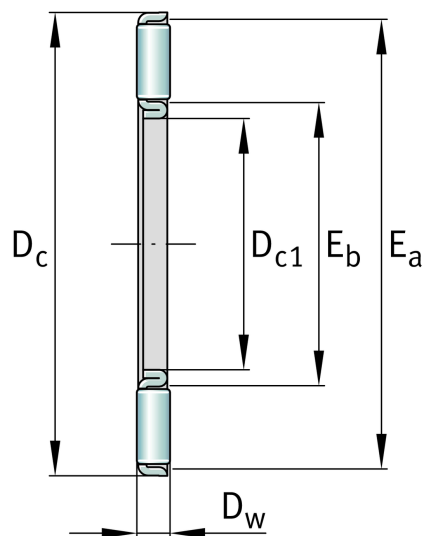
**AXK1024-A/0-10**

Axial needle roller and cage assembly

Schaeffler ID:
0000351149065Axial needle roller and cage assemblies,
single direction, to DIN 5405-2

Technical information

Main Dimensions & Performance Data

D_{c1}	10 mm	Bore diameter cage
D_c	24 mm	Outside diameter
D_w	2 mm	Rolling element diameter
E_a	23 mm	Raceway dimension
E_b	12 mm	Raceway dimension
c_a	9,200 N	Basic dynamic load rating, axial
c_{0a}	25,500 N	Basic static load rating, axial
c_{ua}	2,550 N	Fatigue load limit, axial
n_G	16,900 1/min	Limiting speed
n_{gr}	7,400 N	Reference speed
	3.095 g	Weight

Additional information

AS1024	Axial bearing washer
--------	----------------------

